



Installation Guide & User Manual

**SoundPlus™ WIR TX8 Infrared Emitter,
95 kHz and 250 kHz Carrier**

Large Area Infrared Listening System

Model WIR TX8
Optional Receiver Model WIR RX4



 **WILLIAMS SOUND®**
Helping People Hear



SOUNDPLUS™ WIR TX8 INFRARED EMITTER, 95 KHZ AND 250 KHZ CARRIER

INSTALLATION GUIDE AND USER MANUAL

Contents	Page
SYSTEM OVERVIEW	3
INSTALLATION PROCEDURE	5
TX8 EMITTER COVERAGE PATTERNS	
TX8 EMITTER SETUP	
TX8 POWER WIRING	
USING MULTIPLE EMITTERS	11
CONTROLS AND FEATURE	13
TX8 REAR PANEL	
TX8 BOTTOM PANEL	
RECEIVER SAFETY INFORMATION	14
RECEIVER INSTRUCTIONS	15
RECEIVER MANAGEMENT	15
TROUBLESHOOTING	16
SPECIFICATIONS	17
WARRANTY	19

NOTES: TAKING A FEW MINUTES NOW TO READ THESE INSTRUCTIONS WILL SAVE TIME AND ENSURE PROPER SYSTEM OPERATION.

INFRARED RECEIVER PERFORMANCE CAN BE DEGRADED IF THIS SYSTEM IS USED IN CLOSE PROXIMITY TO HIGH-EFFICIENCY LIGHTING EQUIPMENT WITH SOLID STATE BALLASTS (I.E. HIGH EFFICIENCY FLUORESCENT) THAT OPERATE AT FREQUENCIES NEAR 95 KHZ. 250 KHZ OPERATION SHOULD BE USED WHEN THIS OCCURS.

The TX8 is a CLASS 1 LED PRODUCT



SYSTEM OVERVIEW

The Williams Sound WIR TX8 Infrared Emitter is designed to operate with a WIR TX10 Infrared System or modulator that sends a 95 kHz or 250 kHz frequency modulated signal to the TX8 Emitter via coaxial cable.

The WIR TX8 emits invisible infrared light into the listening area. Infrared receivers detect the transmission and convert the light signals back into audio signals.

The system is designed to transmit high quality audio for hearing assistance and language interpretation applications. Because the system uses infrared light for transmission, it is not affected by radio equipment and does not interfere with radio equipment. No FCC license is required. The coverage area for the TX8 will vary depending on the receiver being used. (see Figures 2 and 4 to demonstrate the receiver coverage area when operating a single TX8 emitter in single channel mode). Generally, a RX4 receiver will operate up to 4,000 ft² (370 m²). Larger areas can be covered by connecting additional WIR TX8 Emitters.

FIGURE 1A: TYPICAL SYSTEM CONFIGURATIONS

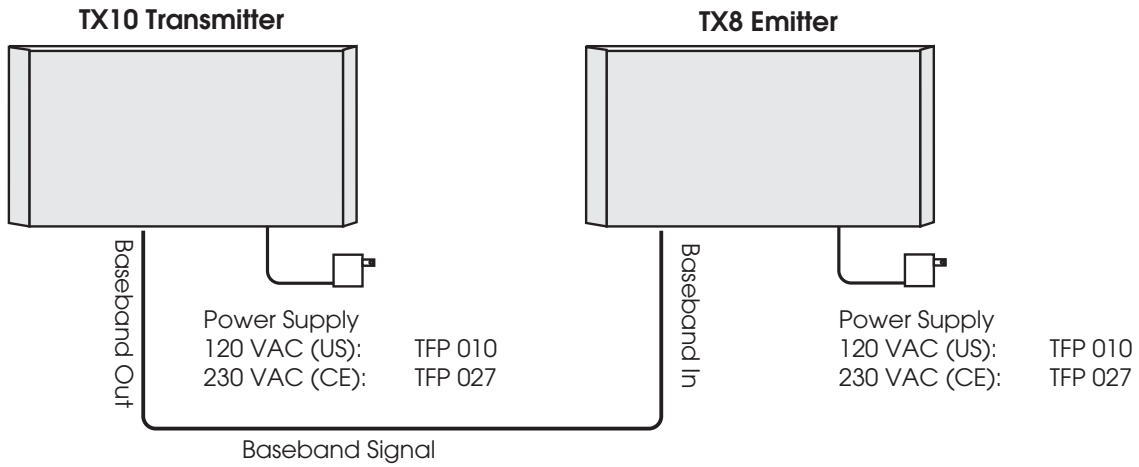
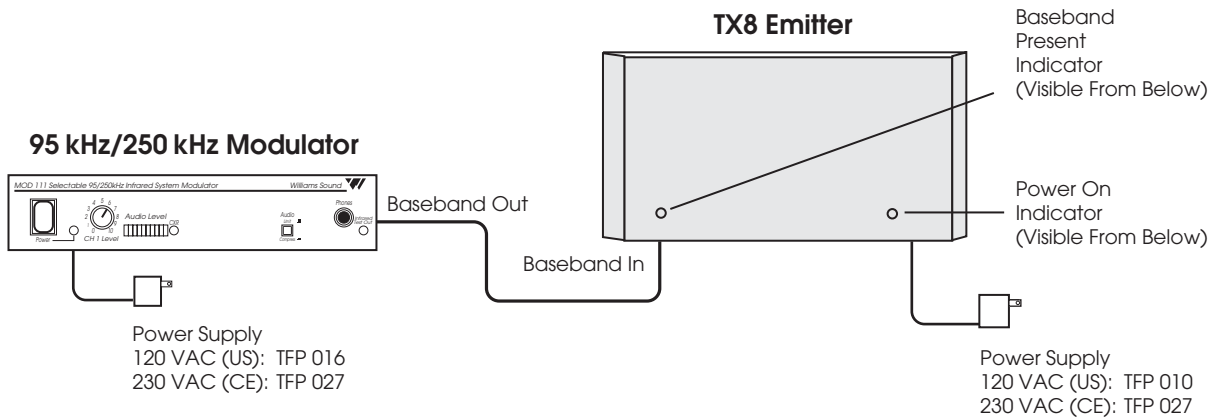
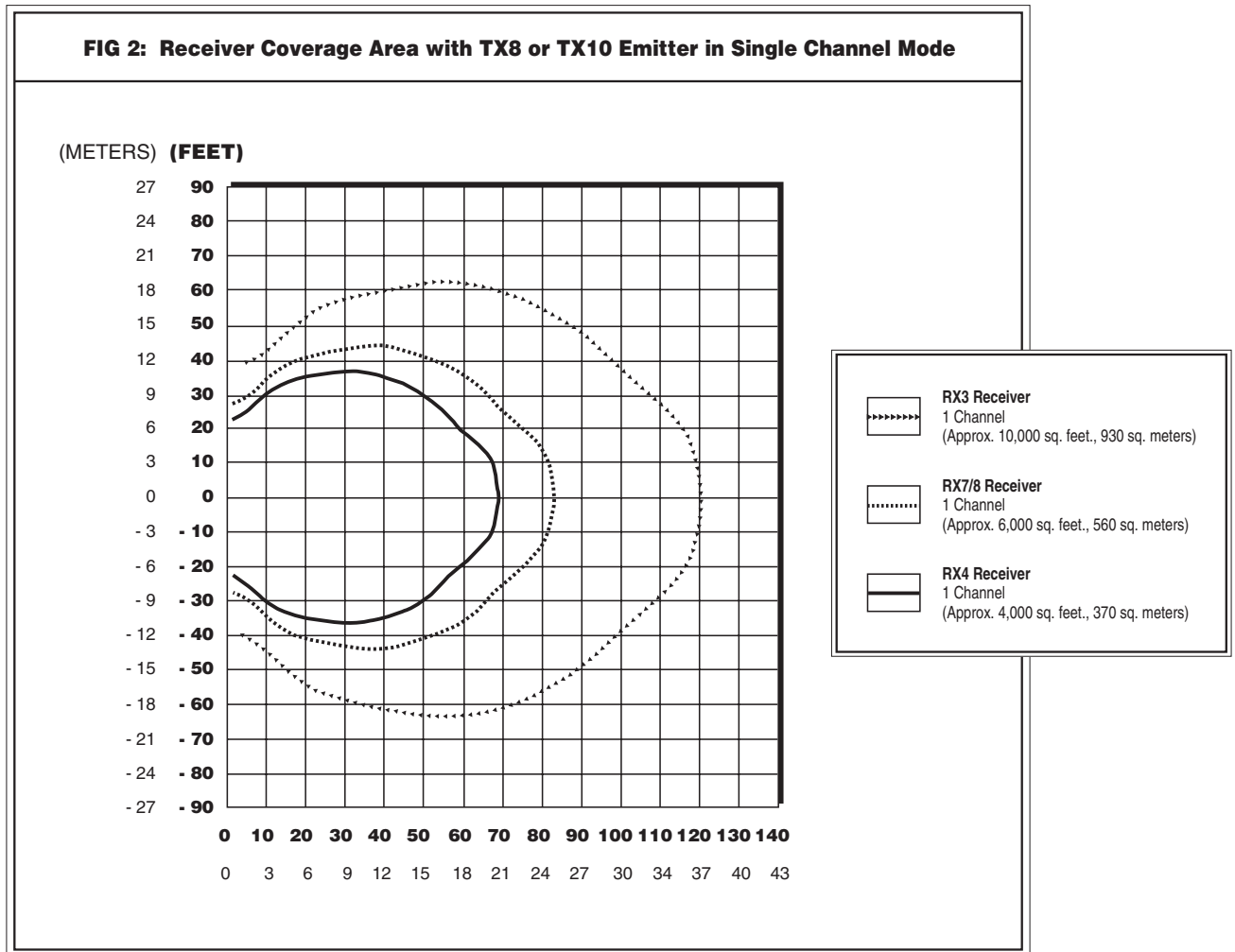

FIGURE 1B: USING A TX8 EMITTER WITH A COMPATIBLE 95kHz/250kHz MODULATOR



TX8 EMITTER COVERAGE PATTERNS

The coverage area for the TX8 will vary depending on the receiver being used. Figures 2 and 4 demonstrate the receiver coverage area when operating a single TX8 emitter in single channel mode. Generally, an RX3 receiver will operate up to 10,000 ft² (930 m²); a RX7/8 receiver will operate up to 6,000 ft² (560 m²); and a RX4 receiver will operate up to 4,000 ft² (370 m²).



These patterns are the direct radiation pattern. The infrared radiation does not drop to zero outside the illustrated patterns; it decreases. It still may be useable at a greater distance, depending on receiver sensitivity and the reflective characteristics of the room.

Reflections of the infrared light from walls, ceilings, and floors may change these patterns.

Important: Remember to point the emitter towards the listening audience!

Remember: opaque objects block infrared light. Thus, the emitters cannot be concealed behind opaque walls, curtains, etc. Neither should emitters be used in areas of extreme high or low temperatures, humidity, or chemical environments.

FIG 3a: 3-Dimension Foot Pattern

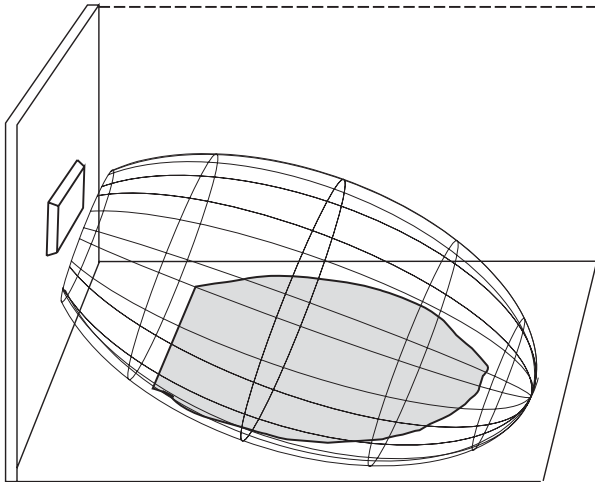

The TX8 floods the listening audience with a cone shape light pattern as shown here.

The path of the cone shape light leaves a pattern on the ground, or "foot print," and indicates where the strongest receiver reception will occur.

The actual coverage area will vary depending on the signal strength of the receiver being used. Refer to Figures 2 and 4 to determine how many emitters are required for 100% coverage of the listening area.

To determine the best location for the emitter, it helps to think of the IR emitter as an invisible floodlight. You'll want to aim it so the listeners are "flooded" with the infrared light. The emitter should also be positioned high enough so it won't be blocked by people and other physical obstructions. See Figure 3b below. **Mount the emitter at least 2 ft. (.61 m) above the audience.** Position the emitter to face in a slightly downward angle - that will increase the "throw" of the infrared beam.

FIG 3b: Vertical Beam Spread

Minimum receiver RANGE when operating with a TX8 or TX10 emitter in Single Channel Mode.

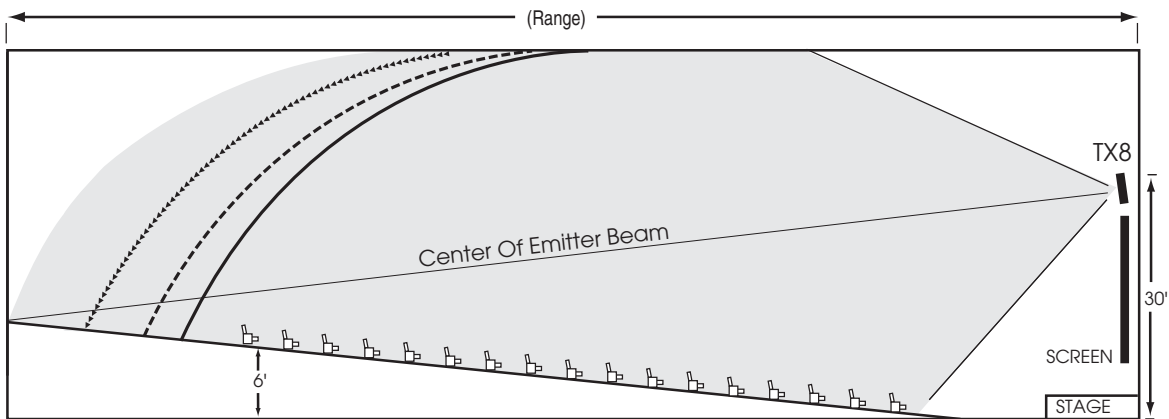
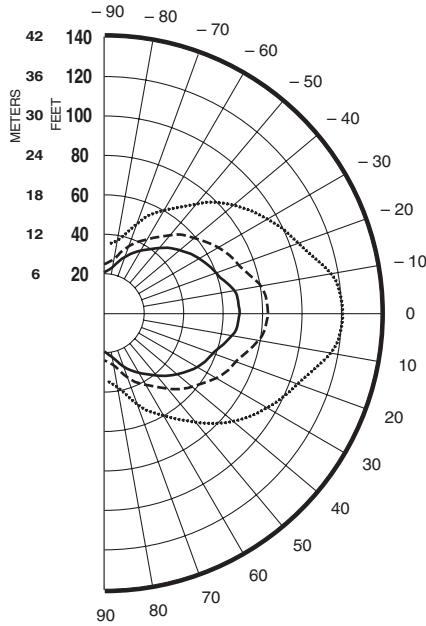





FIG 4: Horizontal and Vertical Radiation Polar Plots

Receiver Coverage Area with a TX8 or TX10 Emitter in Single Channel Mode



HORIZONTAL RADIATION POLAR PATTERNS
DISTANCE FROM EMITTER TO RECEIVER

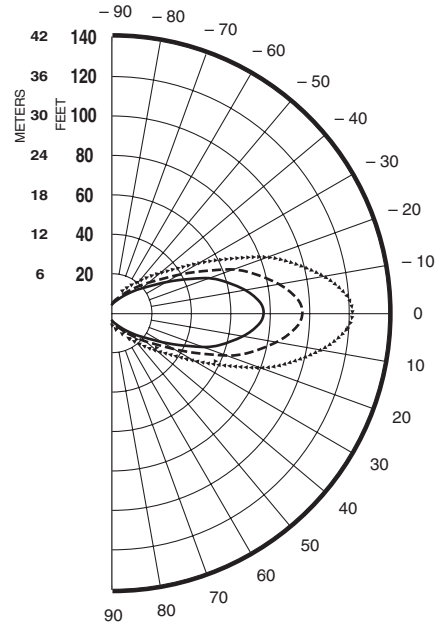

-  **RX3 Receiver**
1 Channel
(Approx. 10000 sq. feet., 930 sq. meters)
-  **RX7/8 Receiver**
1 Channel
(Approx. 6000 sq. feet., 560 sq. meters)
-  **RX4 Receiver**
1 Channel
(Approx. 4000 sq. feet., 370 sq. meters)

VERTICAL RADIATION POLAR PATTERNS
DISTANCE FROM EMITTER TO RECEIVER



-  **RX3 Receiver**
1 Channel
-  **RX7/8 Receiver**
1 Channel
-  **RX4 Receiver**
1 Channel

Reflections of the infrared light from walls, ceilings, and floors may change these patterns.

Important: Remember to point the emitter towards the listening audience!

If you're not getting sufficient coverage with a single, properly installed TX8 Emitter, you'll need to add additional WIR TX8 Emitters to achieve full coverage of your listening area (see instructions on page 11). Figures 5a and 5b illustrate how multiple emitters can be used for large room installations.

Multiple Emitters Installed to Maximize Coverage

FIG. 5a: Overlapping Illumination Patterns to Cover Larger Listening Areas

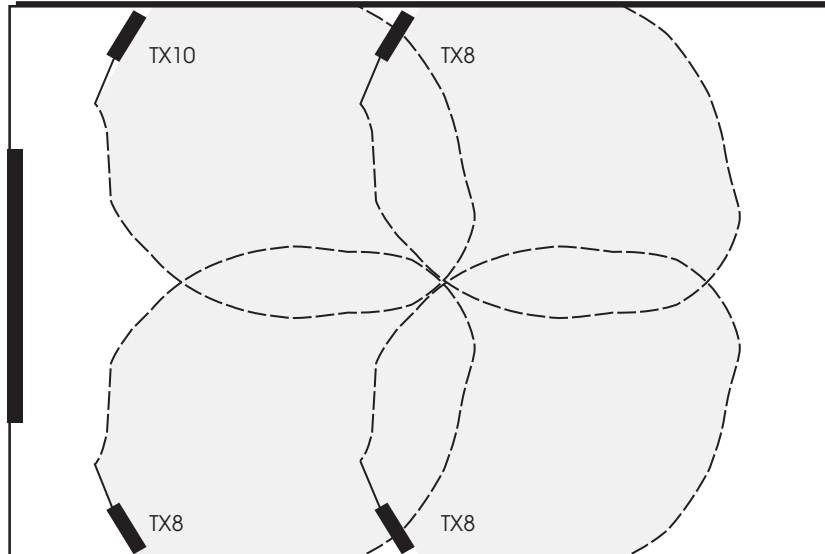
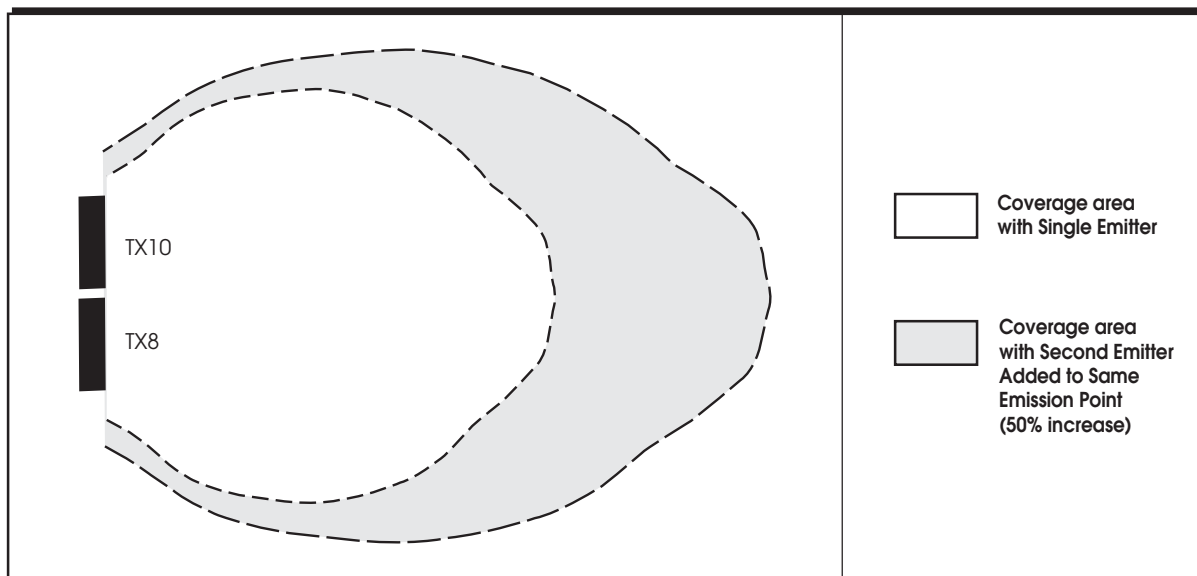

Fig. 5a above is a typical example of how multiple emitters are used to cover larger listening areas. Generally, it is desirable for the illumination patterns to overlap. Note: The coverage area will vary depending on the infrared receiver being used; refer to Figures 2 and 4 to determine how many emitters are required to achieve full coverage of a listening area.

FIG. 5b: Using Two Emitters at Same Emission Point to Increase Coverage Area



When two emitters are used at the same emission point in single channel mode, the overall coverage area increases 50%. When using an RX3 receiver, as a result, the coverage area will increase to 15,000 ft² (1,393 m²); the RX7/8 will increase to 9,000 ft² (836 m²); and the RX4 will increase to 6,000 ft² (557 m²).

INSTALLATION PROCEDURE

The TX8 Infrared Emitter should not be installed outdoors, or where there is a lot of direct sunlight indoors. Sunlight generates infrared interference. Certain types of high-efficiency lighting fixtures can also generate interference at 95 kHz because they use high frequency modulation.

FIG. 6: BRACKET 024 MOUNTING

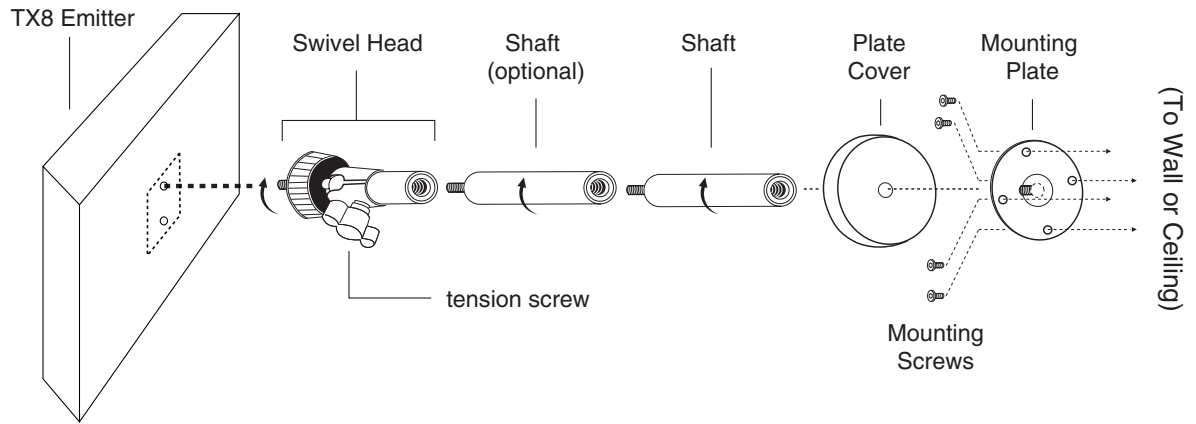

INSTALLATION STEP 1: MOUNTING THE TX8 TO A WALL OR CEILING

- Step 1:** Using the mounting plate (Figure 6) as a template, mark the hole locations on the mounting surface where the TX8 will be installed. See Figure 7 below for optional mounting positions.
- Step 2:** Locate the top mounting hole in the rear of the TX8 emitter. Gently screw the male end of the swivel head on to the emitter. Tighten the swivel head *tension screw*: turn clockwise until the connection is secure.
- Step 3:** Screw the male end of the shaft into the female end of the swivel head. An additional shaft can be added to create more distance between the wall/ceiling and Emitter.
- Step 4:** Place the plate cover snugly over the mounting plate. This will hide the screws after installation.
- Step 5:** Screw the male end of the mounting plate into the female end of the shaft. *For suspended ceilings*, screw the female end of the shaft into the male end of the *T-Bar clip*. The mounting bracket is now installed on to the TX8 Emitter.
- Step 6:** Position the TX8 Emitter and BKT 024 so the mounting plate lines up with the marked holes on the mounting surface. Fasten the mounting plate to the surface using screws and wall anchors. *Mounting the TX8 to a Suspended Ceiling with Cross Tee:* Fasten the T-Bar clip on to the desired Cross Tee.
- Step 7:** Position the TX8 Emitter to the desired angle: Begin by gently turning the tension screw (Figure 6) counter clockwise to release the swivel head. Adjust the TX8 to the desired angle. When the TX8 is in the desired position, gently turn the tension screw clockwise until the swivel head is securely in place.

FIG. 7: WALL OR CEILING MOUNT

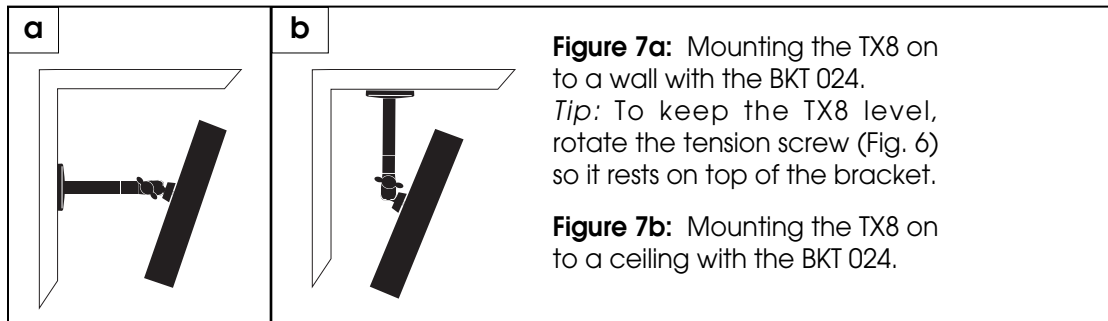

Figure 7a: Mounting the TX8 on to a wall with the BKT 024.
Tip: To keep the TX8 level, rotate the tension screw (Fig. 6) so it rests on top of the bracket.

Figure 7b: Mounting the TX8 on to a ceiling with the BKT 024.

POWER WIRING

FOR U.S. APPLICATIONS:

The TX8 Emitter is supplied with a low-voltage wall transformer power supply (TFP 010). Two-conductor 18 ga. power cord is included with the emitter.

POWER CONNECTIONS FOR APPLICATIONS OUTSIDE THE U.S. REQUIRING 240 VAC MAINS SUPPLY:

WIR TX8

Use an appropriate power adaptor supplied by the local distributor which meets the following Secondary Specifications: **24 VAC, 30 VA, 50/60 Hz**

!! IMPORTANT WARNING !!

SHORTING THE POWER SUPPLY OUTPUT TERMINALS WILL BLOW A NON-REPLACEABLE INTERNAL FUSE, DESTROYING THE POWER SUPPLY UNIT!

POWERLINE VOLTAGE MUST NOT FALL BELOW 94V, OR SYSTEM PERFORMANCE WILL BE GREATLY REDUCED!

DO NOT CONNECT THE POWER SUPPLY TO AC POWER YET!!!

Step 1: Determine the length of power cord needed to reach from the emitter to the AC wall outlet where the power supply will be plugged in. Power cord length must not exceed 200 feet (61 m). If the distance exceeds 200 feet, heavier gauge wire is required. Make sure the power supply is not plugged into AC power yet!

One end of the power cord has a 3-pin Molex connector, the other end is bare. Cut the bare end of the power cord to length. Strip this end down the middle approximately 1 inch, then strip both of the resulting strands about 1/8 inch. Install the crimp-on spade terminals supplied and connect these to the screw terminals on the TFP 010 Power Supply. Polarity is not important since AC power is being used.

Step 2: Plug the 3-pin connector into the TX8's Power In connector.

Step 3: Plug in the TFP 010 Power Supply last.

The Power Indicator LED in the lower right of the front panel glows when the TX8 is on. The Baseband Indicator LED is located in the lower left of the TX8 front panel and glows when a baseband signal is present.

Note: The TX8 transmits when a baseband signal is present. The TX8 shuts off when no baseband signal is present for about 30 minutes. This auto shut-off feature preserves the life of the IR LED's and reduces power consumption when the emitter is not in use.

This system is designed for Class 2, low-voltage wiring. Always follow local electrical codes when doing low voltage wiring.

BASEBAND CABLE CONNECTION

IF YOU ARE USING ONE EMITTER:

Step 1: Determine the length of RG-58 coaxial cable needed to reach from the TX8 emitter to the TX10 infrared system (or compatible 95/250 kHz modulator w/ baseband connections). 100 feet (30 m) of coaxial cable is included with each emitter. You will need to cut it to length. Additional RG-58 coax can be added. Make sure you leave some slack at each end.

Step 2: Install BNC connectors on each end of the cable. (See instruction on page 12.)

Step 3: Connect the Baseband cable to the Baseband Out jack on the TX10 transmitter (or compatible 95/250 kHz modulator) and to the Baseband In jack on the TX8 emitter.

IF YOU ARE USING MORE THAN ONE EMITTER:

- Step 1: Determine the length of coaxial cable needed to reach between the emitters. 100 feet (30 m) of coaxial cable is included with each emitter. You will need to cut it to length. Additional RG-58 coax can be added. Make sure you leave some slack at each end.
- Step 2: Install BNC connectors on each end of the cable. (See instructions on page 12.)
- Step 3: Connect the baseband cable from the Baseband Out Jack on the first emitter in the chain to the Baseband In jack on the next TX8 Emitter in the chain. Use the cable clamps and screws provided to secure the cable. The coax can also be routed through conduit before attaching BNC connectors. You can chain as many emitters together as you need. Remember that each emitter needs its own TFP 010 power supply.

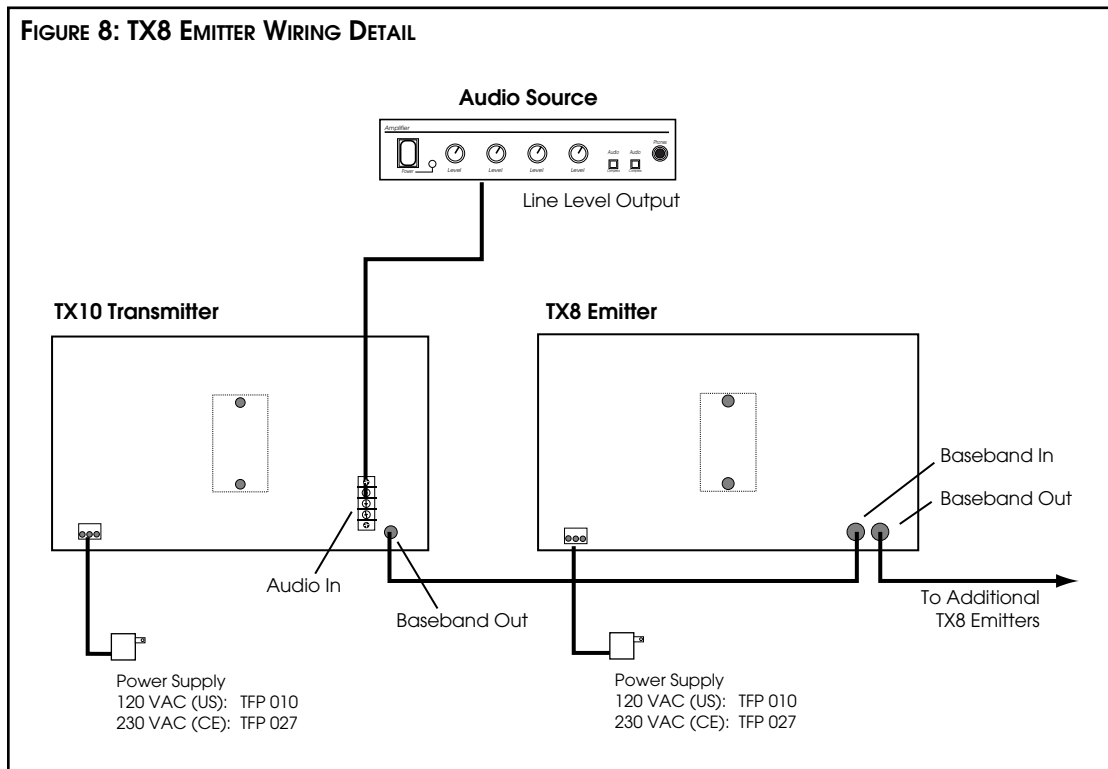
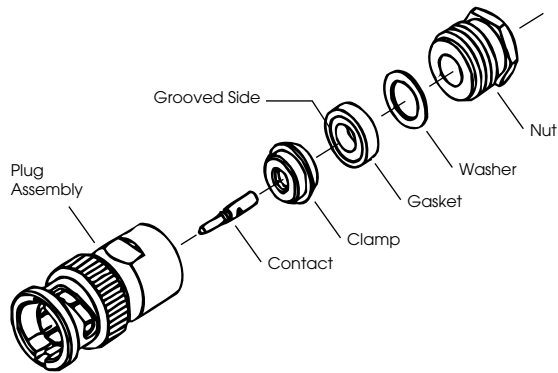

FIGURE 9: BNC CONNECTOR ASSEMBLY



ASSEMBLY PROCEDURE

The BNC Connector consists of a plug assembly, a contact, a clamp, a gasket, a washer, and a nut.

1. Slide nut, washer and gasket over cable end; then strip outer cable jacket using the recommended strip-length dimension in fig. 9b.
2. Slide clamp over cable braid and position it against the cable jacket. After clamp is properly positioned, comb out the braid.
3. Fold cable braid over the clamp and trim it so that it is positioned against the clamp collar. See figures 9c and 9d.
4. Using the dimension in figure 9e, strip dielectric to expose the center conductor. If applicable, tin the center conductor.
5. Solder contact to the conductor (using standard soldering techniques), making sure contact is bottomed on cable dielectric. See figure 9f.

DO NOT allow a hot soldering iron to touch cable dielectric. Certain cable dielectric materials, such as polypropylene, will expand if they come in contact with a hot soldering iron.

6. Insert contact into plug assembly until contact snaps into place. See figure 9g.
7. Thread nut into plug assembly until it is secured. Recommended cable clamp tightening torque is 2.8–3.4 N•m [25–30 in.-lb.], using a 7/16" wrench. See figure 9h.

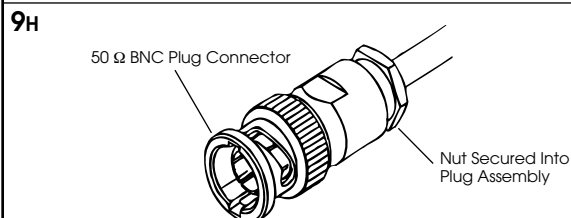
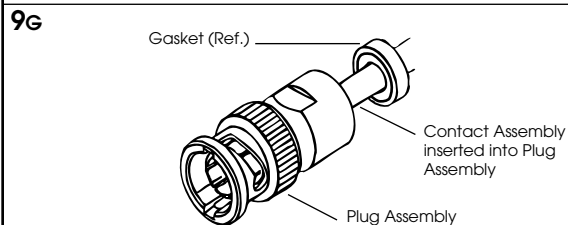
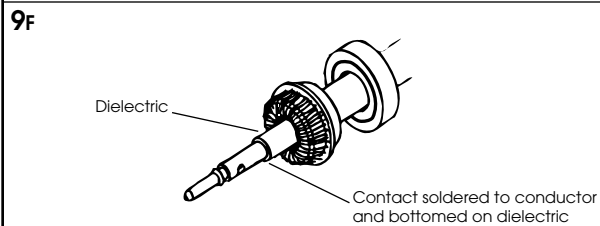
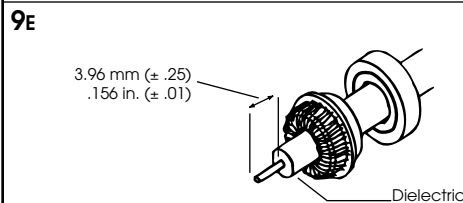
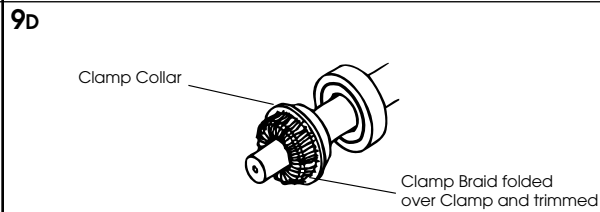
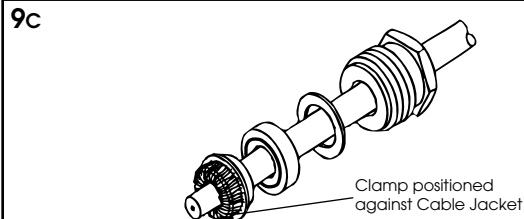
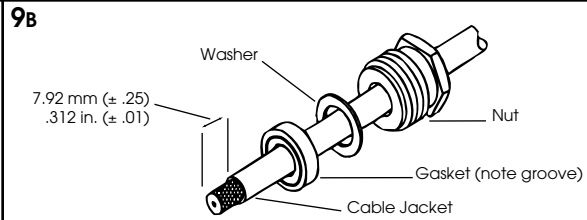

CONTROLS AND FEATURES

POWER INPUT

Three-pin connector for TFP 010 power supply.

POWER INDICATOR LED (FRONT PANEL)

Located on the front panel in the top center of the LED window. Red indicator light glows when power is on. (Note: The TX8 switches to low power mode when no baseband signal is present.)

BASEBAND INDICATOR LED (FRONT PANEL)

Located on the front panel in the bottom center of the LED window. Red indicator light glows when baseband signal is present. (Note: The TX8 switches to low power mode when no baseband signal is present.)

BASEBAND IN:

Connects to the Baseband Out jack of the TX10 Transmitter or another TX8 Emitter.

BASEBAND OUT:

Connects to the Baseband In jack of of the next TX8 Emitter in the chain when multiple emitters are used.

WALL/CEILING MOUNT TEMPLATE:

A mounting bracket (BKT 024) is included with the Emitter. An optional tripod stand kit is also available (SS-6, SS-10, or SS-11).

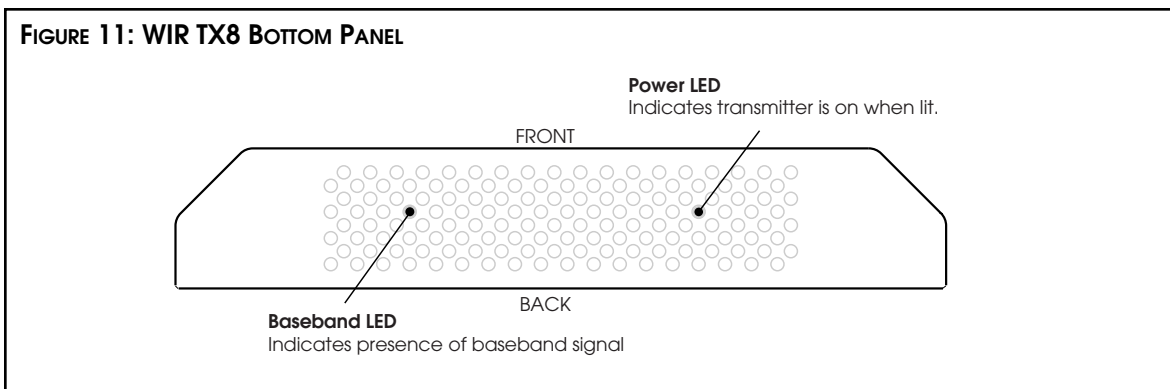
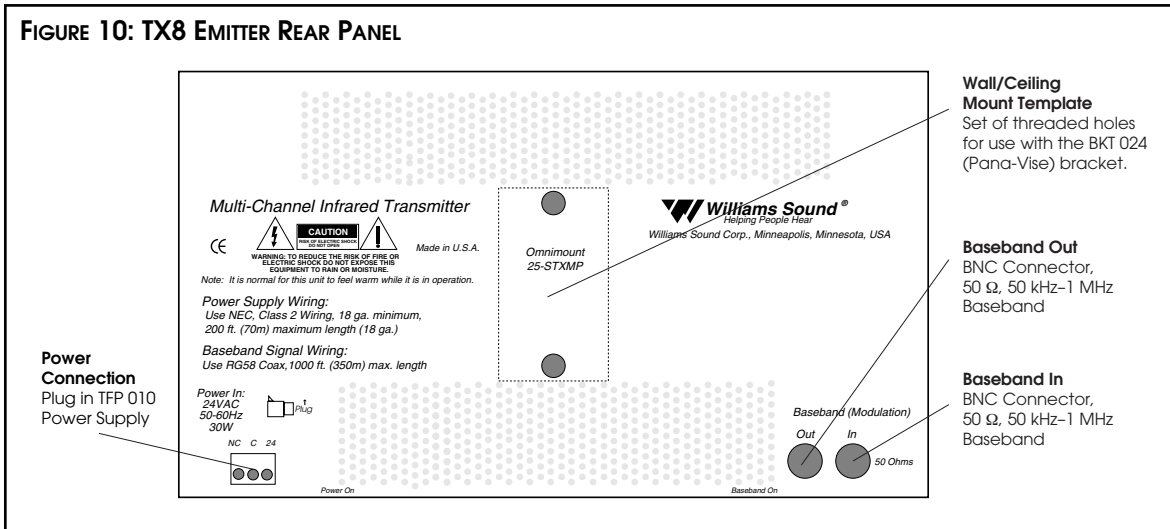

RECEIVER SAFETY INFORMATION

HEARING SAFETY



CAUTION!

This product is designed to amplify sounds to a high volume level which could potentially cause hearing damage if used improperly. **To protect your hearing and the hearing of others:**

1. Make sure the volume is turned down before putting on the earphone or headphone before adjusting the volume to a comfortable level.
2. Set the volume level at the minimum setting that you need to hear.
3. If you experience feedback (a squealing or howling sound), reduce the volume setting and move the microphone away from the earphone or headphone.
4. Do not allow children **or other unauthorized persons** to have access to this product.

BATTERY SAFETY AND DISPOSAL



CAUTION!

This product is supplied with disposable Alkaline batteries. Do not attempt to recharge disposable batteries, which may explode, release dangerous chemicals, cause burns, or other serious harm to the user or product.

PACEMAKER SAFETY:



CAUTION!

1. **Before** using this product with a pacemaker or other medical device, consult your physician or the manufacturer of your pacemaker or other medical device.
2. If you have a pacemaker or other medical device, make sure that you are using this product in accordance with safety guidelines established by your physician or the pacemaker manufacturer.

RECYCLING INSTRUCTIONS

BATTERY SAFETY AND DISPOSAL



Help Williams Sound protect the environment! Please take the time to dispose of your equipment properly.

Product Recycling for Customers in the European Union:

Please do NOT dispose of your Williams Sound equipment in the household trash. Please take the equipment to a electronics recycling center; OR return the product to the factory for proper disposal.

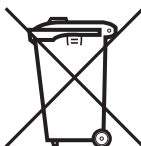

Battery Recycling for Customers in the European Union:

Please do NOT dispose of used batteries in the household trash. Please take the batteries to a retail or community collection point for recycling.

2/22/06

OPTIONAL RECEIVER INSTRUCTIONS

IR RECEIVER MODELS WIR RX4

1. Turn the receiver's Power Switch to ON.
2. Place the headset on your head and find the Volume Control.
3. Adjust the headband size by pulling or pushing on each earpiece.
4. Adjust the headset volume to a comfortable level.

IMPORTANT

The infrared receiver "eye" is located on top of the headset. Do not cover it up or you will lose reception.

Note: To maximize battery life, turn the receiver OFF when it's not in use.

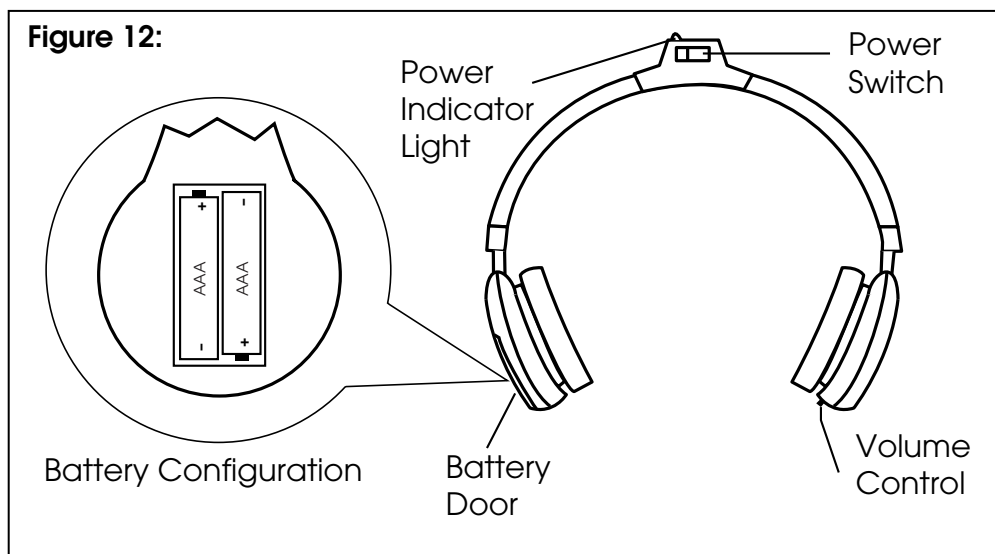

BATTERY INSTRUCTIONS

This receiver can use disposable AAA batteries (carbon, alkaline, or lithium) or AAA NiMH rechargeable batteries. For longer lasting performance, we recommend using BAT 010 AAA Alkaline batteries.

EXPECTED BATTERY LIFE

BAT 010 Alkaline batteries: 50 hours

Batteries from other suppliers may provide different operating life.

INSTALLING AND REPLACING BATTERIES

1. Open the battery compartment by sliding the cover down.
2. Remove depleted batteries.
3. To install new batteries, press them into place, observing proper polarity (+/-). A diagram inside the compartment shows the correct configuration.
4. Close the battery compartment cover by sliding it back into place.
5. When the sound becomes weak or distorted, replace or recharge batteries.

TROUBLESHOOTING

NEITHER TX8 INDICATOR LIGHT IS ON (FIGURES 1B, 10 & 11).

- ▶ Make sure the wall transformer is plugged into the emitter and the power switch or any remote power switch is on.
- ▶ Make sure the electrical outlet is on.
- ▶ Make sure the 24 VAC power supplies are working.

ONLY TX8'S POWER INDICATOR LED COMES ON (FIGURES 1B, 10 & 11).

- ▶ If the TX8 is connected to a TX10 infrared system: make sure the TX10 power indicator is ON and check to make sure there is an active audio source coming into the TX10
- ▶ If the TX8 is connected to a 95/250 kHz compatible modulator: make sure the modulator power indicator is ON and check to make sure there is an active audio source coming into the modulator

NO SOUND THROUGH RECEIVERS.

- ▶ If some of the receivers work but others don't, check for bad batteries or earphones on the receivers that aren't working.
- ▶ If none of the receivers work, check to see if the power and baseband cable are connected to the emitter and that the Power and Baseband Indicator lights are ON.
- ▶ If a 95/250 kHz compatible modulator is being used, check to make sure it is properly connected to the sound system. The On Indicator on the modulator should be lit and there should be activity on modulator's level indicators.
- ▶ Make sure the "eye" is not covered up on the receiver. There must be clear line of sight between the receiver eye and the emitter panel.
- ▶ Make sure the selected modulator frequency matches the selected receiver frequency.

SOUND THROUGH THE RECEIVERS IS WEAK AND NOISY.

- ▶ Try increasing the input signal level from the sound system by turning up a mixer control. If the signal sounds okay, you may need to re-position the emitter panels or add additional panels.

NOTE: Make sure the powerline voltage does not fall below 94V, or system performance will be greatly reduced!

BUZZING OR HUMMING NOISE IN SOUND SYSTEM.

- ▶ Check for ground loops or noise on the input signal. Call your Authorized Dealer or Williams Sound for help.

SYSTEM SPECIFICATIONS

INFRARED EMITTER, MODEL WIR TX8

Dimensions, Weight:	11.25" W x 6.25" H x 2.125" D (28.6 cm x 15.9 cm x 5.4 cm) 1.9 lbs. (0.9 kg)
Color:	Black epoxy paint with white legends, red acrylic window
Wall Mount:	BKT 024 mounting bracket included for wall and ceiling mounting.
Tripod Mount:	Optional SS-6 Tripod Stand Kit available
Power:	External power supply, 24 VAC, 50 or 60 Hz, 50 VA, 0.9 A nom. current drain Emitter shuts off when baseband signal is not present
Operating Req.:	0-50° C ambient temperature, non-condensing, non-corrosive atmosphere
Coverage Area:	Single-Channel Mode: RX3 Receiver: 10,000 ft ² (930 m ²); RX7/8 Receiver: 6,000 ft ² (560 m ²); RX4 Receiver: 4,000 ft ² (370 m ²) 50° cone pattern; For larger areas, connect add'l WIR TX8 Emitters
Infrared Type:	Class 1 LED Product
FRONT PANEL:	
Power Indicator:	Red LED, visible from bottom through vent holes, lower right
Baseband Indicator:	Red LED, visible from bottom through vent holes, lower left
REAR PANEL:	
Mounting Holes:	One set of threaded holes for use with the BKT 024 mounting bracket (included) Two threaded holes on sides of the cabinet for Tripod Stand Kit
Baseband Input:	BNC connector, 50 Ω, 50 kHz to 500 kHz carriers, 100 mV nominal per carrier, 10 V RMS maximum aggregate baseband amplitude
Baseband Output:	BNC connector, 50 Ω, 50 kHz to kHz baseband
Baseband Cable:	RG-58 Coax, BNC-connectors
Power:	External power supply, 3-pin molex connector, 24 VAC, 50 or 60 Hz, 30 VA, 0.9 A nom. current drain
Power Cable:	NEC Class 2 wiring, 2-conductor, 18 ga.; 200 foot (61 m) max. length for 18 gauge wire (See table below for minimum gauge requirements at other lengths) Each TX8 Emitter requires its own 24 VAC Power Supply

<u>Cable Length Required</u>	<u>Minimum Wire Gauge</u>
0 - 10 feet (3 m)	22 gauge
0 - 75 feet (23 m)	20 gauge
0 - 200 feet (61 m)	18 gauge
0 - 500 feet (152 m)	16 gauge
0 - 1,000 feet (305 m)	14 gauge

Warranty:	Five Years, Parts and Labor. 90 days on cords, earphones, headphones, batteries and other accessories
-----------	--

NOTE: **SPECIFICATIONS SUBJECT TO CHANGE WITHOUT NOTICE.**
Infrared receiver performance can be degraded if this system is used in close proximity to high-efficiency lighting equipment with solid state ballasts (i.e. high efficiency fluorescent) that operate at frequencies with harmonics near 95 kHz. 250 kHz operation should be used when this occurs



INFRARED RECEIVER, MODEL WIR RX4 (OPTIONAL)

Weight:	5.4 oz (154 g) with batteries
Earpad Size:	6.5 cm (2.5") diameter, adjustable headband, uses HED 023 foam cushions
Material and Color:	ABS plastic, Textured Gray
Battery Type, Life:	2 - AAA Alkaline, 40 hours
Modulation Frequency:	95 kHz FM, 50 μ S de-emphasis
Deviation:	\pm 50 kHz
Frequency Response:	200 Hz to 8 kHz, \pm 5 dB
Signal-to-Noise Ratio:	60 dB at 4 m
Controls:	On/Off slide switch, volume control wheel
Acoustic Output:	110 dB MAX SSPL90, 100 dB HF AVG SSPL90 with 2 cc coupler
Compatibility:	Compatible with most wide-band 95kHz IR Transmitters
Speakers:	Moving coil type. Compatible with telecoil-equipped hearing aids
Warranty:	5 years (excludes microphones, headphones, batteries and chargers)



LIMITED WARRANTY

Williams Sound products are engineered, designed, and manufactured under carefully controlled conditions to provide you with many years of reliable service. Williams Sound warrants the SoundPlus Infrared Emitter against defects in materials and workmanship for FIVE (5) years. During the first five years from the purchase date, we will promptly repair or replace the SoundPlus Infrared Emitter.

Microphones, earphones, headphones, batteries, chargers, cables, carry cases, and all other accessory products carry a 90-day warranty.

WILLIAMS SOUND HAS NO CONTROL OVER THE CONDITIONS UNDER WHICH THIS PRODUCT IS USED. WILLIAMS SOUND, THEREFORE, DISCLAIMS ALL WARRANTIES NOT SET FORTH ABOVE, BOTH EXPRESS AND IMPLIED, WITH RESPECT TO THE SOUNDPLUS INFRARED EMITTER, INCLUDING BUT NOT LIMITED TO, ANY IMPLIED WARRANTY OF MERCHANTABILITY OR FITNESS FOR A PARTICULAR PURPOSE. WILLIAMS SOUND SHALL NOT BE LIABLE TO ANY PERSON OR ENTITY FOR ANY MEDICAL EXPENSES OR ANY DIRECT, INCIDENTAL OR CONSEQUENTIAL DAMAGES CAUSED BY ANY USE, DEFECT, FAILURE OR MALFUNCTIONING OF THE PRODUCT, WHETHER A CLAIM FOR SUCH DAMAGES IS BASED UPON WARRANTY, CONTRACT, TORT OR OTHERWISE, THE SOLE REMEDY FOR ANY DEFECT, FAILURE OR MALFUNCTION OF THE PRODUCTS REPLACEMENT OF THE PRODUCT. NO PERSON HAS ANY AUTHORITY TO BIND WILLIAMS SOUND TO ANY REPRESENTATION OR WARRANTY WITH RESPECT TO THE SOUNDPLUS INFRARED EMITTER. UNAUTHORIZED REPAIRS OR MODIFICATIONS WILL VOID THE WARRANTY.

The exclusions and limitations set out above are not intended to, and should not be construed so as to contravene mandatory provisions of applicable law. If any part or term of this Disclaimer of Warranty is held to be illegal, unenforceable, or in conflict with applicable law by a court of competent jurisdiction, the validity of the remaining portions of this Disclaimer of Warranty shall not be affected, and all rights and obligations shall be construed and enforced as if this Limited Warranty did not contain the particular part or term held to be invalid.

If you experience difficulty with your system, call Toll-Free for Customer Assistance:

1-800-843-3544

If it is necessary to return the system for service, your Customer Service Representative will give you a Return Authorization Number (RA) and shipping instruction.

Pack the system carefully and send it to:

**Williams Sound Corp.
Attn: Repair Dept.
10321 West 70th Street
Eden Prairie, MN 55344 USA**

Your warranty becomes effective the date you purchase your system. Your returned warranty card is our way of knowing when your warranty begins. It also gives us important information about your system including the serial number. This information will help us serve you better in the future. Please take a moment to complete and mail the attached card. Thank you.

